

Pressure Gauges / Manifolds / 2 Way Manifolds / MP2W222

CONSTRUCTIVE PROPERTIES		
	STANDARD	OPTIONAL
Mounting Type	Vertical	-
Case	Stainless Steel AISI-316L	Monel 400 Hastelloy C276 Stainless Steel 316 Ti Stainless Steel AISI-304
Open-Close Wheel	Stainless Steel AISI-316L	Monel 400 Hastelloy C276 Stainless Steel 316 Ti
Orifice Diameter	4 mm.	-
Inlet Connections	1/2" NPT	1/4" NPT 1/2" BSPP 1/4" BSPP 1/2" BSPT 1/4" BSPT
Outlet Connections	1/2" NPT	1/4" NPT 1/2" BSPP 1/4" BSPP 1/2" BSPT 1/4" BSPT
Drain Plug	1/4" NPT	-
Packing	PTFE	Graphoil

USAGE PROPERTIES		
Fluid Temperature	-73 °C...+210 °C	-54 °C...+510 °C
Operating Pressure (max.)	6000 psi/413 bar	10000 psi/698 bar
Leakage Test	Helium Sniffer Leakage Test	
Conformity	NACE MR 1075 O2	



MP2W222BSN2N2PS

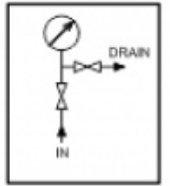
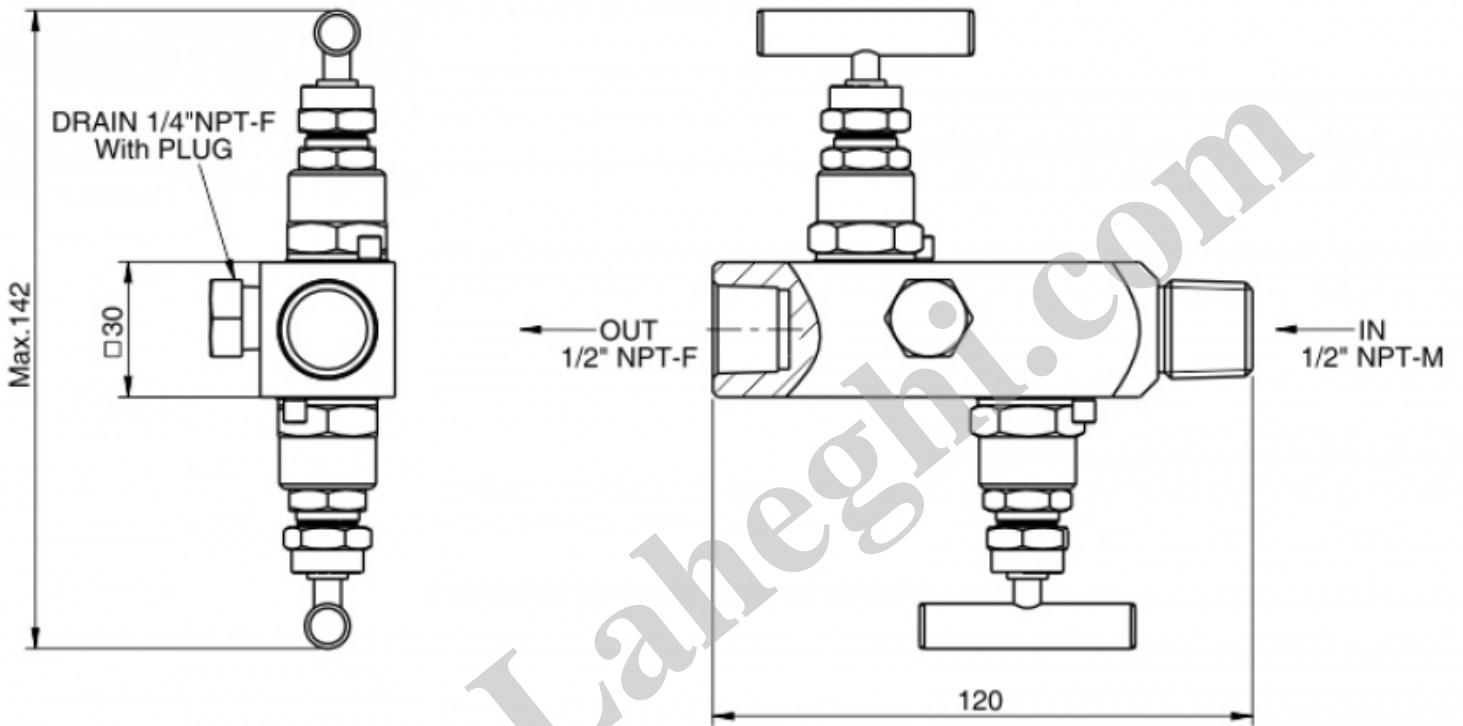

Model No: MP2W222BSN2N2PS

Vertical